

Sliding wardrobe

Modularity

HEIGHTS

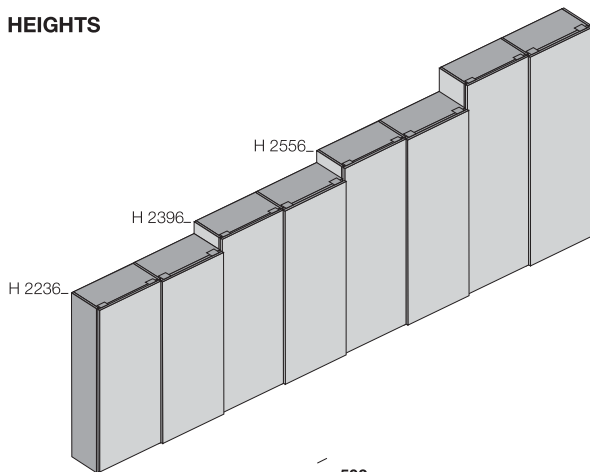

H 2876
For door:
 - Liscia
 - Sinua liscia
 - Breccia liscia
 - Tratto
 - Vertigo

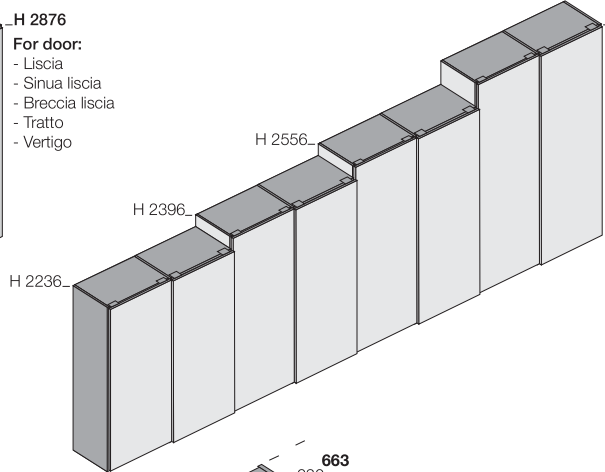

H 2876
For door:
 - Liscia
 - Sinua liscia
 - Breccia liscia
 - Tratto
 - Vertigo

DEPTH D 503

(quote calculated with doors thickness 26 mm)

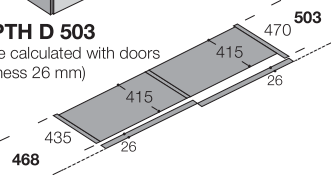

DEPTH D 663

(quote calculated with doors thickness 26 mm)

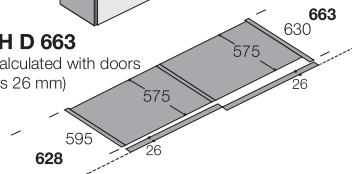

MODULAR WIDTHS

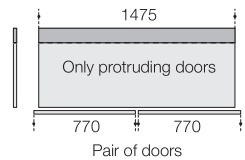
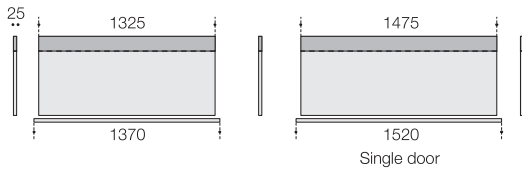
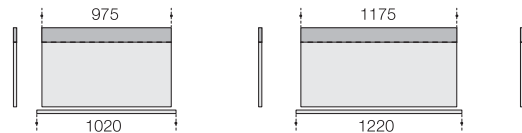
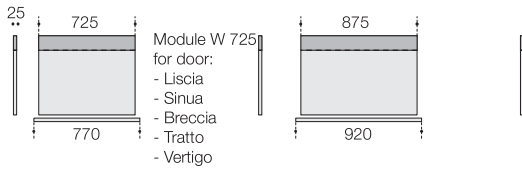

To compose the wardrobe and find its price, add to the tall units the cost of side panels and partitions.
Interior fittings:
 - 1 shelf
 - Clothes hanger rails

CORNER WITH STRUCTURE D 435

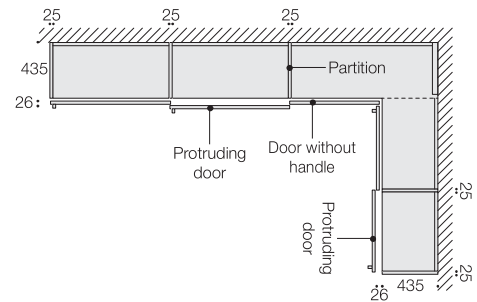

CORNER WITH STRUCTURE D 595

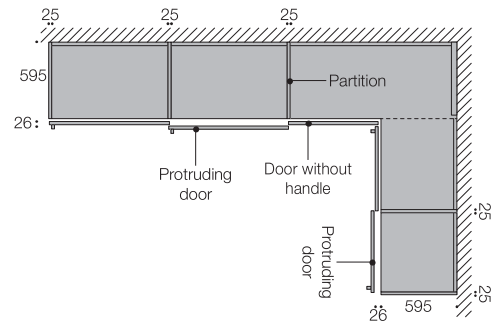









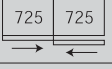
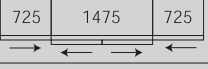

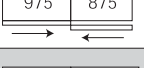

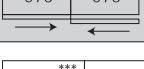
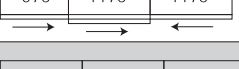

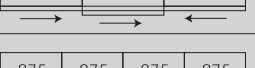



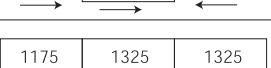

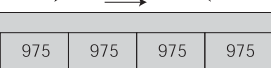
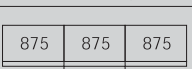
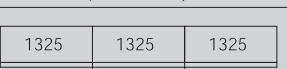
Compartments adjacent to corner modules must always have protruding doors.

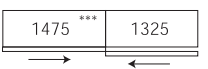
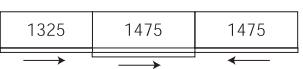
SLIDING

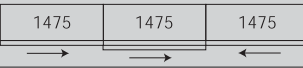
Sliding wardrobe

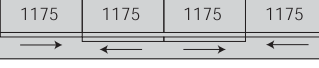
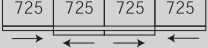
Modularity

WARDROBE WIDTH	ELEMENTS WIDTH	WARDROBE WIDTH	ELEMENTS WIDTH
1525		3025	
1825		3025	
1925		3225	
2025		3425	
2225		3625	
2275		3625	
2425		3775	
2575		3925	
2725		4025	
2725		4075	
2825		4225	
2875		4375	
2925		4525	
3025		4825	
3025			

*** This compartment cannot be opened completely and it cannot be fitted with drawer units, pull-out shelves or clothes lifts.

Wardrobe combinations in the price list on page 222

Sliding wardrobe

Technical notes

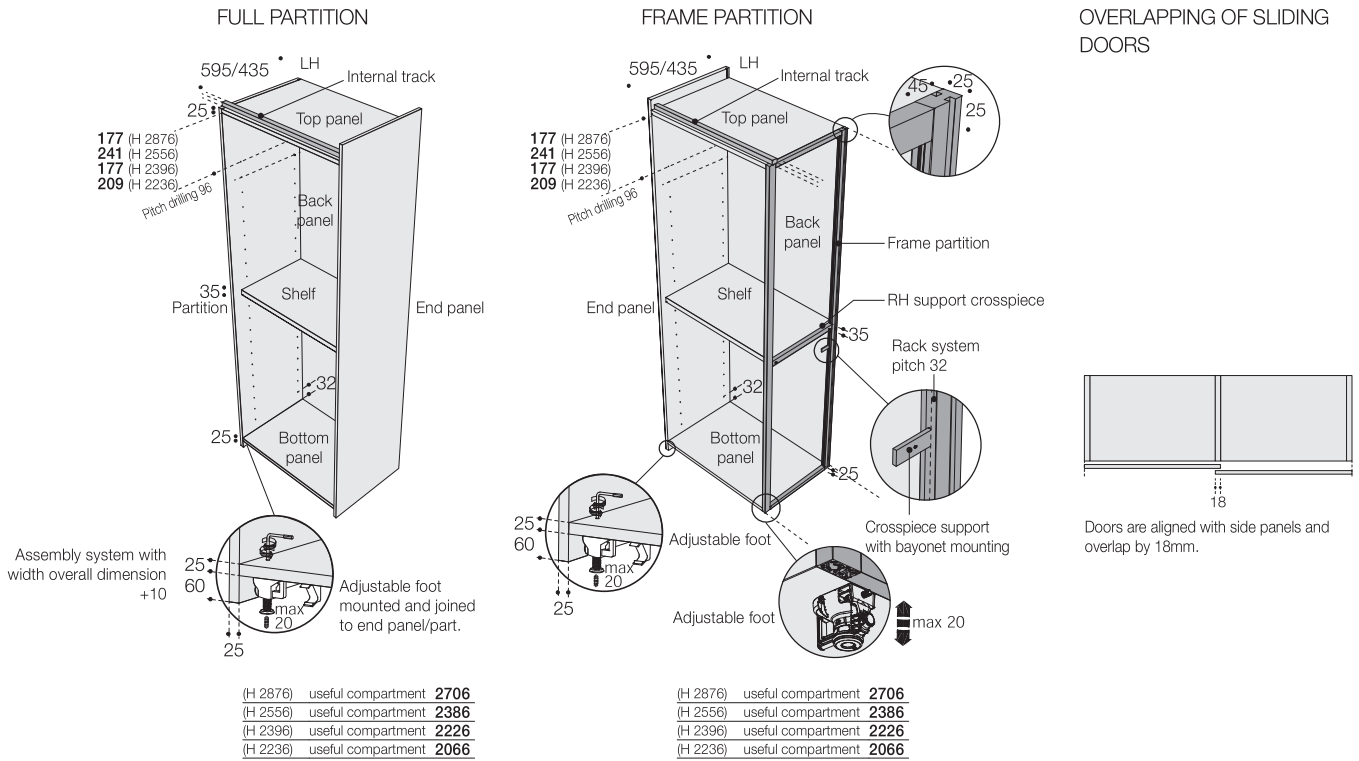

SLIDING TRACK

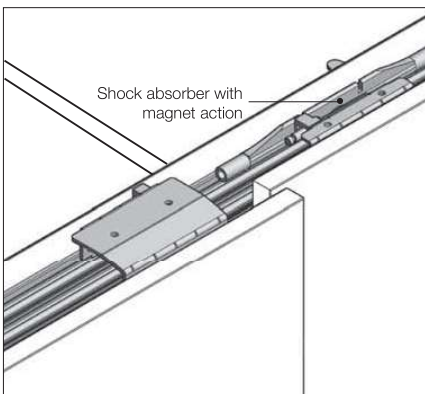

- All sliding wardrobes are fitted, as standard, with SOFT-CLOSE MECHANISM with silence and fluid action

CLOTHES HANGER RAILS



- Prices of modules include clothes hanger rail in Piombo and Brown finish
 - Clothes hanger rail support designed SANGIACOMO

HARDWARE FOR WALL FIXING WARDROBE

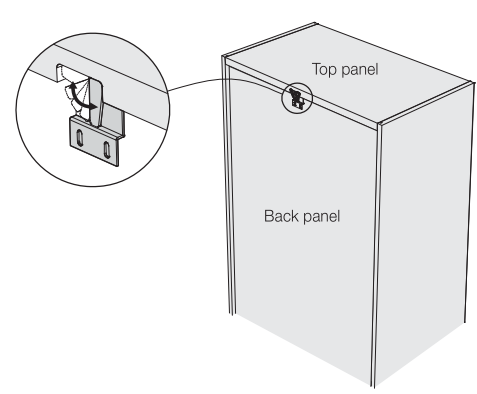

- In wardrobes D. 435 at least two compartments are provided with an anti-tilting attachment to be fixed to a wall.
 - At least one compartment of 595 deep wardrobes is provided with a non-tilting attachment to be used when required.
 - The non-tilting plates to secure to the wall come with spacers so that they can be used with maximum 15mm thick skirting board.

ASSEMBLY NOTES

Necessary space for wardrobe assembly:
 Width +35 - Height +60

The door can be regulated from the front and does not need more upper space.

Sliding wardrobe

VR - VERTIGO door

MODULARITY

Width: 725 - 875 - 975 - 1175

FINISHES

MELAMINE FINISH

- Frassinato Canapa (horizontal grain)
- Frassinato Bianco 10 (horizontal grain)
- Olmo Medio and Scuro (vertical grain)
- Loto Natura, Loto Tortora and Loto Terra
- Tramato Lino

LACQUERED MELAMINE FINISH

- Matt Lacquered wood effect in the colours of the range (horizontal grain)

LACQUERED

- Matt lacquered in the colours of the range
- Gloss lacquered in the colours of the range
- Metal lacquered Bronzo-Ottone-Rame

VENEERED

- Rov. Carbone (horizontal grain)
- Rov. Grigio (horizontal grain)
- Rov. Cenere (horizontal grain)
- Rov. Argilla (horizontal grain)
- Rov. Termotrattato (vertical grain)
- Noce Canaletto (verticale grain)

MATERIAL FEATURES

DOOR IN MELAMINE FINISH AND LACQUERED MELAMINE

Panel in *wood particle board faced with melamine or matt lacquered with polyurethane paint. ABS edge in the same finish as the door.

LACQUERED DOOR

Honeycomb-core panel faced with laminate, glossy or matt lacquered with polyurethane paint. ABS edge in the same finish as the door.

For customized solutions the door will be delivered with a full wood particle board panel.

VENEERED DOOR

Honeycomb-core panel veneered in open pore coloured brushed Oak or veneered in Rovere termotrattato or brushed Noce Canaletto, open pore transparent painted. Wooden edge in the same colour as the door.

DOORS COME WITH DUST-PROOF PROFILE AND EXTERNAL ADJUSTABLE TIE BARS

*Wood and derivatives components according to the following standards: E1-TSCA-CARB-UBA.

VERTIGO PROFILE FINISHES

MATT LACQUERED

- Matt lacquered in the colours of the range

PAINTED

- Brown - Piombo

METAL LACQUERED

- Bronzo - Ottone - Rame

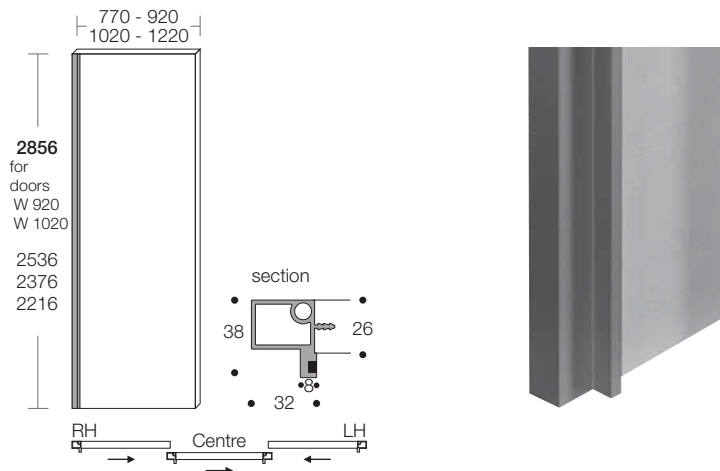

Sliding wardrobe

SC - SCRIGNO door

MODULARITY

Width: 875 - 975 - 1175

GLASS FINISHES

- Transparent smoked grey
- Satin smoked grey
- Resin fabric

MATERIAL FEATURES

GLASS

Tempered glass Th. 4

FRAME

Aluminium profile with epoxy paint for Brown and Piombo finish.

FRAME FINISHES

PAINTED

- Brown - Piombo

